

TURN SIGNAL SWITCH

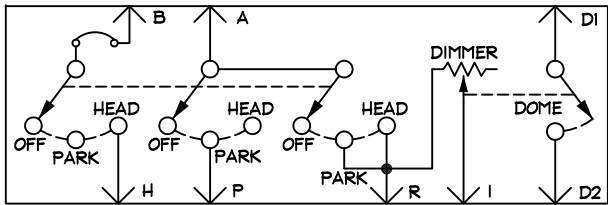

HEADLIGHT SWITCH

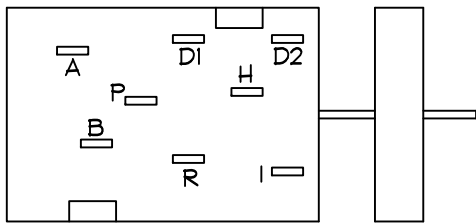

BOTTOM VIEW

**EITB-11654-AA
1985 FORD F-150**

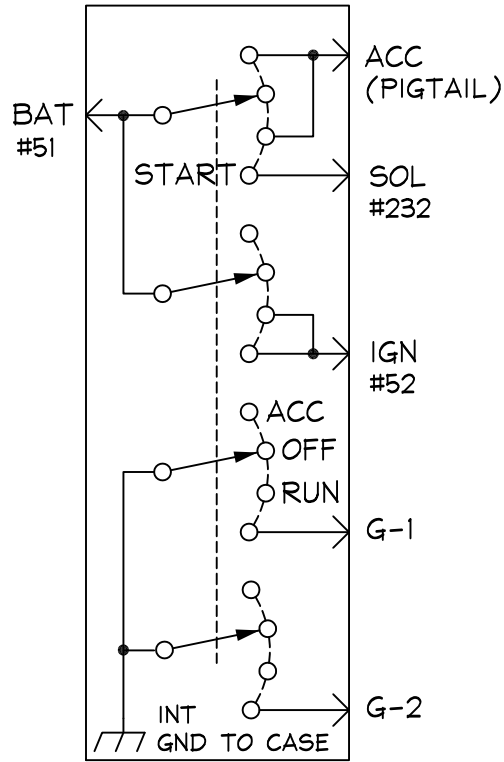

IGNITION SWITCH

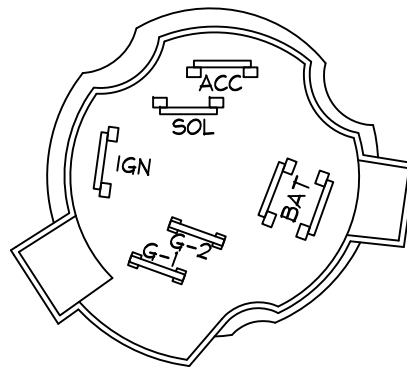

72 CHEVY C-10 PICK UP

WIRE SIDE of CONNECTOR

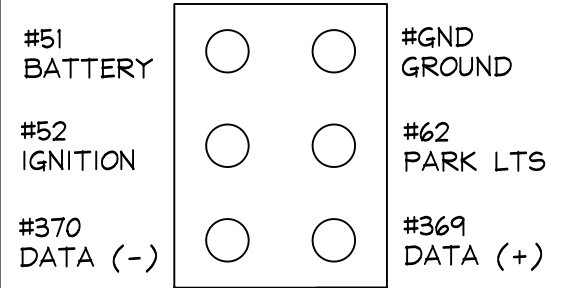

**MAGNUM INTELLIDRIVE
VEHICLE COMPUTER**

SEALED BEAM

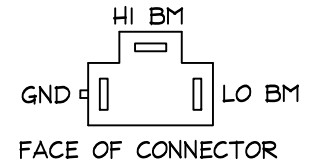

HEADLIGHT CONNECTORS

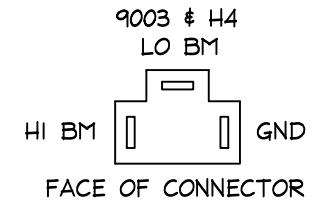

ADD IGNITION SWITCH 7/2/09

SCALE:N/A

PROJECT:SAFARI

TITLE:ELECTRICAL COMPONENTS

ADD TURN SIGNAL SWITCH 5/18/10

DRAWN:JIM EXLER

LOC: CAMARILLO

DRG: COMPONENT 1

REVISION

DATE: 8/25/08

JOB NO:N/A

AutoElectric1.dwg

2